

tinyWireless PIC32 / PIC24 Development Board

MT1 MT2
 MTPPT-2.1MM MTPPT-2.1MM
 MT3 MT4
 MTPPT-2.1MM MTPPT-2.1MM

PIC32 32-bit / PIC24 16-bit USB uC

IO Headers

ICSP Headers

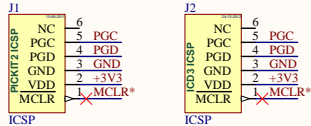

USB Connector

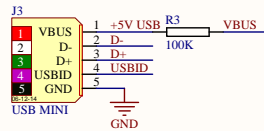

UART Connector

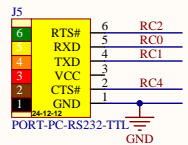

Power Supply

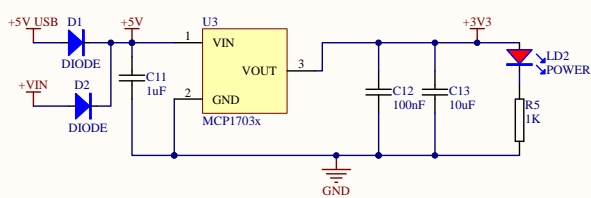

LED

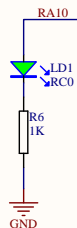

Program / User Button

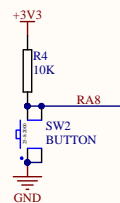

32Mbit SPI Flash

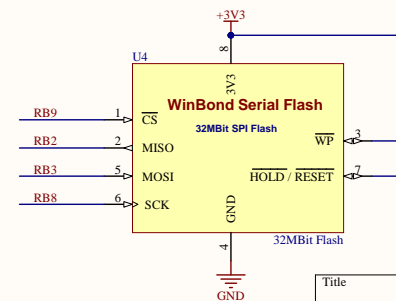

RFM69HW Wireless Module

