

picoTRONICS32 - PIC32 (32-bit) USB Microcontroller Development Board

PIC32 - 32-bit USB uC

ICSP Headers

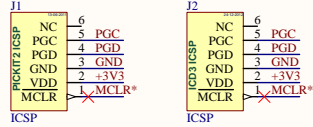

USB Connector

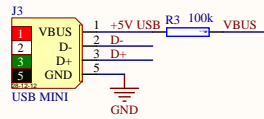

UART Connector

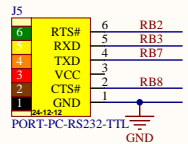

Power Supply

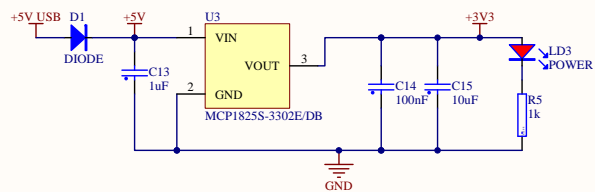

Optional LED



Optional Button

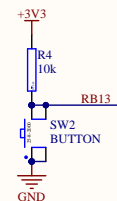

IO Headers

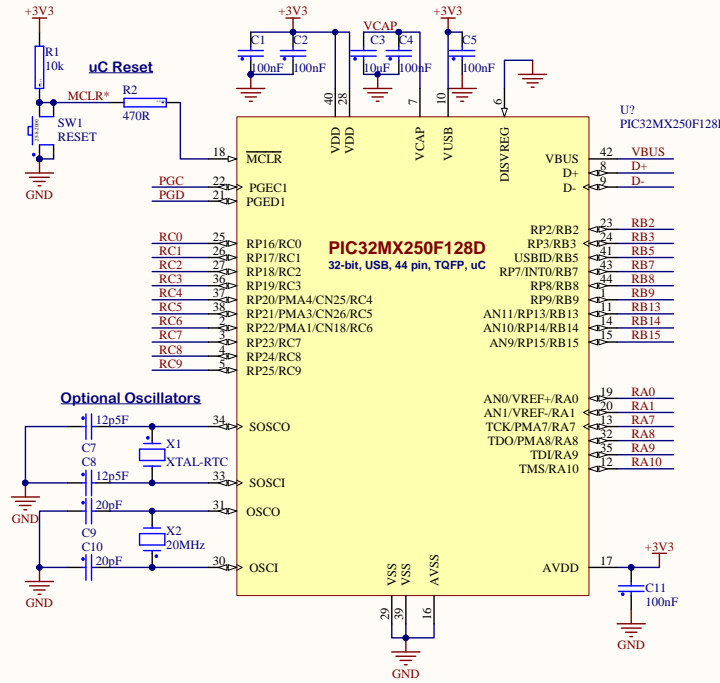
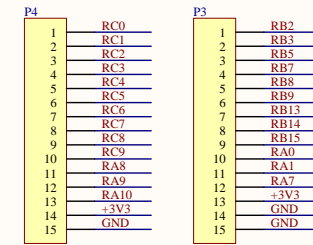

Title		
Size	Number	Revision
A3		
Date:	27/09/2014	Sheet of
File:	C:\Users\...picoTRONICS32_v1.SchDoc	Drawn By: