

## ICSP Headers

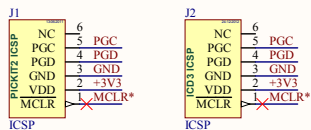

## PIC24 - 16-bit USB uC

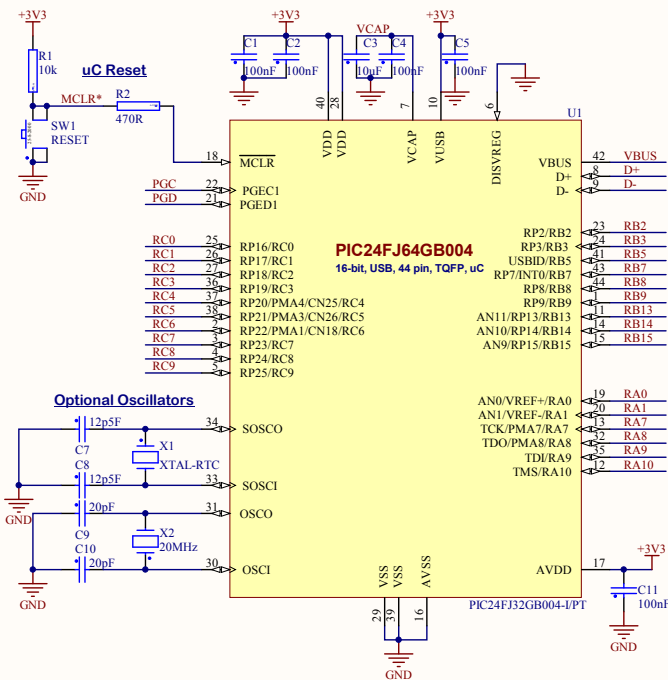

## IO Headers

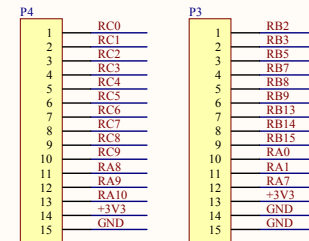

## USB Connector

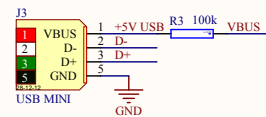

## UART Connector

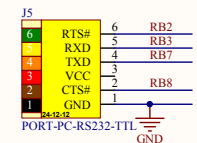

## Mounting Holes



## Power Supply

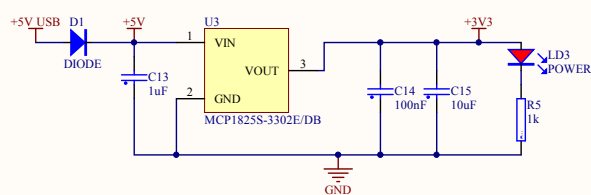

## Optional LED

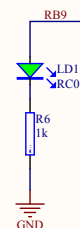

## Optional Button

